

# Regenerate MS-9A89 System for IIoT

with Ultimate Expansions and 3.5" SBC Embedded

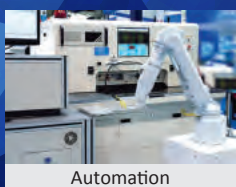

Embedded with Industrial Wide Temperature for Various Applications



Automation



Transportation



Medical



Digital Signage

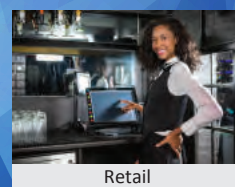

Retail

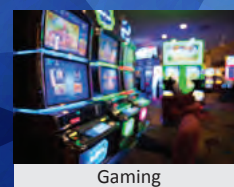

Gaming

# Industrial PCs for IIoT

## Compact-Size Box PC with Intel® Kaby Lake-U/Skylake-U or Apollo Lake-I Series Processor for Ultra Low-Power Fanless Solution

### MS-9A89-U1/ MS-9A89-U2/ MS-9A89-U3

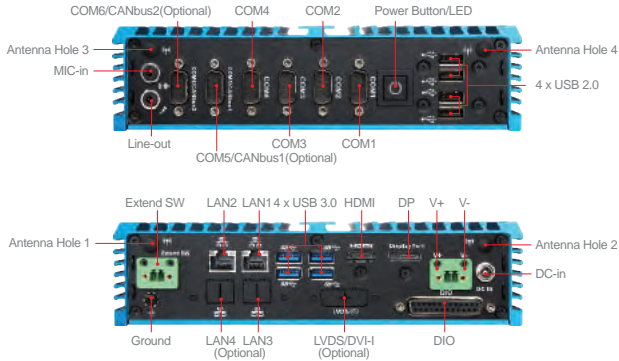

- 6th/7th Gen U-series CPU with high performance low power consumption
- Support 8 USB ports

### MS-9A89-A1/ MS-9A89-A2

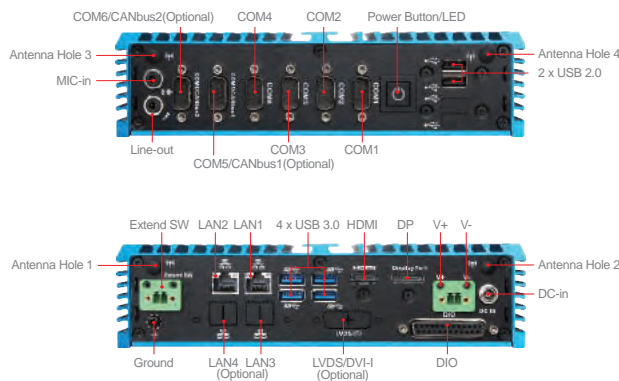

- Atom E3900 series CPU with wide temperature characteristic
- DDR3L 1866/1600 MHz SO-DIMM Memory up to 8 GB

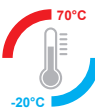

- Wide-range operating temperature: up to -20~+70 °C (for A1 only)

### Features

- Support 16-bit GPIO(8\*GPI; 8\*GPO)
- Equipped 3 independent displays with HDMI, DP, and LVDS/DVI-I(optional)
- Dual mini-PCIe for expansions
- Wide DC in 12~24V
- 4 openings reserved for antennas
- Anti-Vibration & Shockproof Design
- EN50155 Compliance

NEW

### Specifications

		MS-9A89-U1	MS-9A89-U2	MS-9A89-U3	MS-9A89-A1	MS-9A89-A2
<b>Processor</b>	CPU	Intel® KBL-U Core™ i3-7100U Processor, DC, 15W	Intel® SKL-U Core™ i5-6300U Processor, DC, 15W	Intel® SKL-U Core™ i3-6100U Processor, DC, 15W	Intel® Atom™ x7 Process E3950, QC, 12W	Intel® Atom™ x5 Processor E3940, QC, 9.5W
	Frequency	2.4GHz			1.6GHz, up to 2.0GHz	1.6GHz, up to 1.8GHz
	L2 Cache	3MB			2MB	
	CPU Type	BGA				
	Chipset	Integrated in Process			Integrated in SoC Process	
<b>Memory</b>	BIOS	AMI				
	Technology	Single channel for DD			Single channel for DDR3L 1866/1600 MHz	
	Max. Capacity	Up to 16GB			Up to 8GB	
<b>Display</b>	Socket	1 x 260-pin SO-DIMMs			1 x 204-pin SO-DIMMs	
	Controller	Intel® HD Graphics				
<b>Display</b>	Graphic Memory	Shared system memory up to 1.7 GB SDRAM				
	Multiple Display	2 or 3 independent displays				
	Display Interface	HDMI1.4 up to 4096 x 2160 @24Hz DP up to 3840 x 2160 @60Hz (Support DP++) LVDS up to 1920 x 1200 @60Hz (optional by cable) DVI-I up to 1920 x 1200 @60Hz (optional by MS-99C0)			HDMI up to 3840 x 2160 @30Hz DP up to 4096 x 2160 @60Hz LVDS up to 1920 x 1200 @60Hz (optional by cable) DVI-I up to 1920 x 1200 @60Hz (optional by MS-99C0)	
<b>Ethernet</b>	Controller	1 x Intel® I210-AT GbE LAN 1 x Intel® I219-LM GbE LAN PHY		2 x Intel® I210-IT GbE LAN	2 x Intel® I210-AT GbE LAN	
<b>Audio</b>	Controller	Realtek® ALC887-VD2-CG HD Audio Codec				
<b>H/W Monitor</b>	Watchdog Timer	256-level Watchdog Timer				
<b>TPM</b>	Controller	N/A				
<b>Expansion Slot</b>	Mini-PCIe	2 x Full-size (Mini-PCIe1 Slot w/ NANO SIM-Holder) (Mini-PCIe2 Slot w/ mSATA)				
<b>Storage</b>	SATA	1 x 2.5" HDD/SSD Bay				
	mSATA	1				
<b>I/O Interface</b>	RJ-45	4 (LAN1/2 Standard, LAN3/4 by Option)				
	PoE	2 x 802.11af (by request)				
	Audio	1 x Line-out / 1 x Mic-in				
	USB	4 x USB 3.0, 4 x USB 2.0			4 x USB 3.0, 2 x USB 2.0	
	Serial	6 x COM ports COM1: RS-232/422/485, 0V/5V/12V COM2-6: RS-232, 0V/5V/12V				
	GPIO	16-bit (8*GPI; 8*GPO), 5V				
	CANbus	2 x CAN 2.0B (optional)				
	HDMI	1				
	LVDS	1 (optional)				
	DVI	1 (DVI-I by option)				
<b>Power Supply</b>	DisplayPort	1				
	Antenna	4 openings reserved for antennas				
<b>Environment</b>	DC Input	DC-in 12V~24V				
	Operating Temperature	-10~45°C (HDD) -10~60°C (w/ WT SSD/mSATA)			-10~45°C (HDD) -20~70°C (w/ WT SSD/mSATA)	-10~45°C (HDD) -10~60°C (w/ WT SSD/mSATA)
	Operating Humidity	10 ~ 90%, non-condensing				
	Storage Temperature	-20 ~ 80°				
<b>Form Factor</b>	Storage Humidity	10 ~ 90%, non-condensing				
	Vibration	IEC61373 Category 1, Class B:				
	Shock	IEC61373 Category 1, Class B				
<b>Software Platform</b>	Dimensions (Wx DxH)	215 x 155 x 55mm				
	Weight	1.55 kg				
	Mounting	Wall mount(STD)/DIN-rail mount(STD)/ VESA mount(by BOM option)				
<b>Software Platform</b>	EMC	CE, FCC, VCCI, RCM, BSMI, EN50155				
	Safety	BSMI				
<b>Software Platform</b>	OS Support	Windows 7(For Skylake-U SKUs) Windows 8.1(For Skylake-U SKUs) Windows 10 (64-bit) Linux Fedora 25 (by request) Linux Ubuntu 16.04 (by request)				

# Customization for Flexible Extend Functions

## Compact-size with Multiple Ports & Expansions



## Two mPCIe Slots Create 8-Type of Combinations

Modules Combination	mPCIe Modules			
	 Dual Isolated LAN Module(WT) EtherCAT	 Dual Isolated PoE Module(WT) (By Requested I/O Bracket) EtherCAT	 Dual Isolated CANbus 2.0B Module (Share By COM5, COM6)	 Four RS232 Module (By Requested I/O Bracket)
<b>MS-99C0</b> LVDS Change Into DVI-I Converter Board  DVI-I Up to 1920x1200 @ 60Hz	V		V	
	V			V
		V	V	
		V		V
<b>MS-99C5</b> Power USB Extension Card (Rear I/O Bracket)  Multi-I/O function with 1*24V power USB, 2*12V power USB and 1*cash drawer	V			
		V		
			V	
				V

# Customization for Flexible Extend Functions

## SMA Wireless Antenna Types

Wi-Fi



LTE



Wi-Fi + LTE



## Flexibility of Installation Types

Wall mount



DIN-Rail

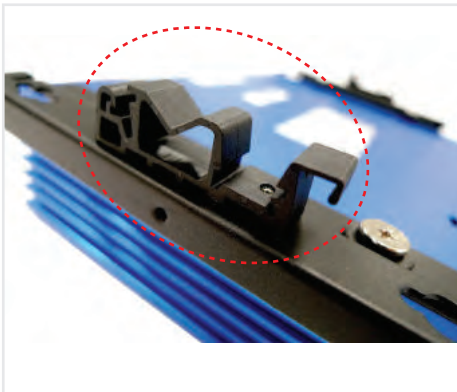

VESA mount



## Certifications



EN50155

